



Touch fittings are mainly used during "plastic" tubes assembly for pneumatic installation especially in case of vibrations or extreme climatic conditions (that involve changes on tube features by passing time).

The fitting tube connection takes place through the clamping of a metal ring which makes it safe and reliable during time.

Les raccords à coiffe sont particulièrement appropriés dans l'assemblage de tuyaux "plastique" pour les systèmes pneumatiques, en particulier là où il peut y avoir des vibrations ou des conditions climatiques extrêmes (qui pourront dans le temps altérer les caractéristiques du tube). Le raccordement du tuyau au raccord se fait à travers le serrage d'un écrou qui le rend sûr et fiable dans le temps.

I raccordi a calzamento sono particolarmente adatti negli assemblaggi di tubi "plastici" in impianti pneumatici, in particolar modo dove possano esserci vibrazioni o condizioni climatiche estreme (che comportano nel tempo mutamenti alle caratteristiche del tubo). L'aggancio del tubo al raccordo avviene infatti attraverso il serraggio di una ghiera che lo rende sicuro e affidabile nel tempo.

ORDERING CODE / CODIFICATIONS / CHIAVE DI CODIFICA

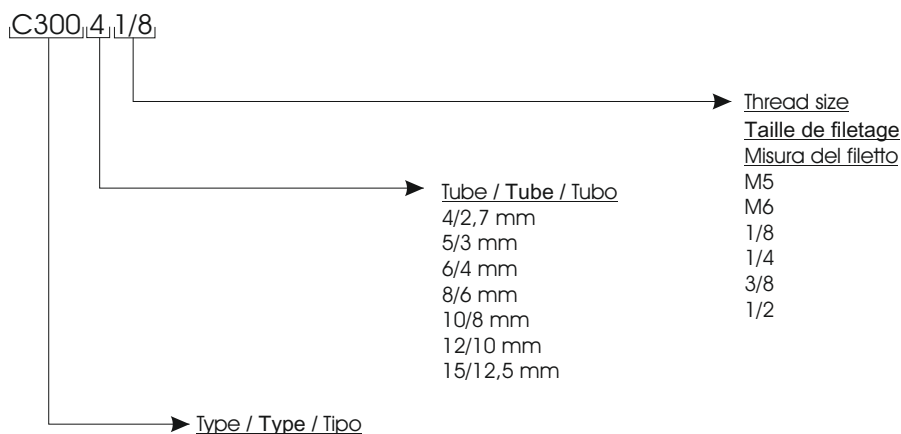

TECHNICAL DATA / DONNÉES TECHNIQUES / DATI TECNICI

Fluid / Fluide / Fluido	Air / Air / Aria
Temperature range / Température d'utilisation / Temperatura di esercizio	-20C° / +70C°
Max operating pressure / Pression d'utilisation max. / Pressione massima	18 bar
Material / Matière / Materiale	brass / laiton / ottone UNI EN 12164 CW 614N brass / laiton / ottone UNI EN 12165 CW 617N
Surface used / Traitement de surface / Trattamento superficiale	nickel-plating / nickelage / nichelatura
Threads / Filetage / Filettature	parallel / cylindrique / cilindrica DIN EN ISO 228 taper / conique / conico DIN EN 10226 (DIN 2999) metric / métrique / metrico DIN ISO 262
Recommended tubes / Tubes recommandés / Tubi raccomandati	Nylon, polyethylene, Rilsan, polyurethane Nylon, polyéthylène, PVC Rilsan, polyuréthane Nylon, polietilene, PVC Rilsan, poliuretano

STRAIGHT MALE ADAPTOR TAPER / DROIT MÂLE CONIQUE / DIRITTO MASCHIO CONICO

C301

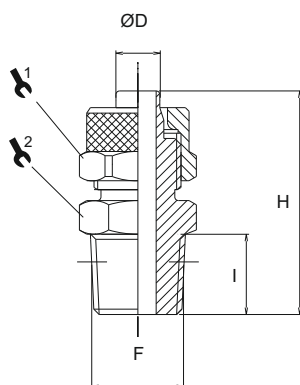

CODE	ØD	F	I	H	1	2	3
C301 4-1/8	4/2,7	R1/8	8,0	23,8	8	12	50
C301 5-1/8	5/3	R1/8	8,0	25,0	8	12	50
C301 6-1/8	6/4	R1/8	8,0	27,5	12	12	50
C301 6-1/4	6/4	R1/4	11,0	31,0	12	14	50
C301 6-3/8	6/4	R3/8	11,5	31,5	12	17	50
C301 8-1/8	8/6	R1/8	8,0	27,5	14	12	50
C301 8-1/4	8/6	R1/4	11,0	31,0	14	14	50
C301 8-3/8	8/6	R3/8	11,5	31,5	14	17	50
C301 8-1/2	8/6	R1/2	14,0	34,5	14	22	50
C301 10-1/8	10/8	R1/8	8,0	29,5	16	14	50
C301 10-1/4	10/8	R1/4	11,0	32,5	16	14	50
C301 10-3/8	10/8	R3/8	11,5	33,0	16	17	25
C301 10-1/2	10/8	R1/2	14,0	36,0	16	22	25
C301 12-3/8	12/10	R3/8	11,5	34,5	18	17	20
C301 12-1/2	12/10	R1/2	14,0	37,5	18	22	20
C301 15-1/2	15/12,5	R1/2	14,0	39,5	22	22	10

STRAIGHT MALE ADAPTOR PARALLEL / DROIT MÂLE CYLINDRIQUE / DIRITTO MASCHIO CILINDRICO

C302

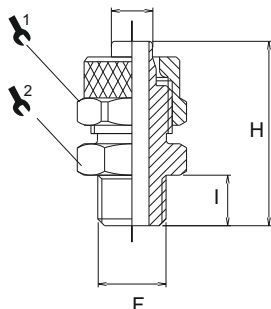

CODE	ØD	F	I	H	1	2	3
C302 5-1/8	5/3	G1/8	6,0	23,0	8	14	50
C302 6-1/8	6/4	G1/8	6,0	25,5	12	14	50
C302 6-1/4	6/4	G1/4	8,0	28,0	12	17	50
C302 6-3/8	6/4	G3/8	9,0	29,0	12	19	50
C302 8-1/8	8/6	G1/8	6,0	25,5	14	14	50
C302 8-1/4	8/6	G1/4	8,0	28,0	14	17	50
C302 8-3/8	8/6	G3/8	9,0	29,0	14	19	50
C302 10-1/8	10/8	G1/8	6,0	27,0	16	14	50
C302 10-1/4	10/8	G1/4	8,0	29,5	16	17	50
C302 10-3/8	10/8	G3/8	9,0	30,5	16	19	25
C302 10-1/2	10/8	G1/2	10,0	32,0	16	24	25
C302 12-3/8	12/10	G3/8	9,0	32,0	18	19	20
C302 12-1/2	12/10	G1/2	10,0	33,5	18	24	20
C302 15-1/2	15/12,5	G1/2	10,0	35,5	22	24	10

STRAIGHT MALE ADAPTOR PARALLEL WITH O-RING / DROIT MÂLE CYLINDRIQUE AVEC JOINT / DIRITTO MASCHIO CILINDRICO CON O-RING

C302C

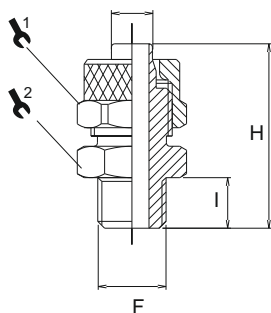

CODE	ØD	F	I	H	1	2	3
C302C 4-1/8	4/3	G1/8	-	-	-	-	50
C302C 5-1/8	5/3	G1/8	6,0	23,0	8	14	50
C302C 6-1/8	6/4	G1/8	6,0	25,5	12	14	50
C302C 6-1/4	6/4	G1/4	8,0	28,0	12	17	50
C302C 6-3/8	6/4	G3/8	9,0	29,0	12	19	50
C302C 6-1/2	6/4	G1/2	-	-	-	-	50
C302C 8-1/8	8/6	G1/8	6,0	25,5	14	14	50
C302C 8-1/4	8/6	G1/4	8,0	28,0	14	17	50
C302C 8-3/8	8/6	G3/8	9,0	29,0	14	19	50
C302C 8-1/2	8/6	G1/2	-	-	-	-	50
C302C 10-1/8	10/8	G1/8	6,0	27,0	16	14	50
C302C 10-1/4	10/8	G1/4	8,0	29,5	16	17	50
C302C 10-3/8	10/8	G3/8	9,0	30,5	16	19	25
C302C 10-1/2	10/8	G1/2	10,0	32,0	16	24	25
C302C 12-3/8	12/10	G3/8	9,0	32,0	18	19	20
C302C 12-1/2	12/10	G1/2	10,0	33,5	18	24	20
C302C 15-1/2	15/12,5	G1/2	10,0	35,5	22	24	10

STRAIGHT FEMALE ADAPTOR / DROIT FEMELLE / DIRITTO FEMMINA

C304

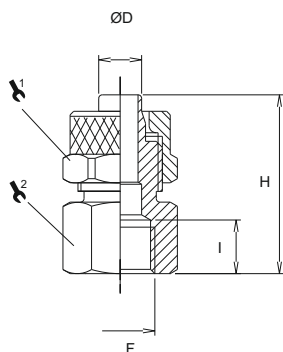

CODE	ØD	F	I	H			
C304 4-1/8	4/2,7	G1/8	8,0	21,3	8	14	50
C304 5-1/8	5/3	G1/8	8,0	22,5	8	14	50
C304 6-1/8	6/4	G1/8	8,0	25,0	12	14	50
C304 6-1/4	6/4	G1/4	11,0	29,0	12	17	50
C304 6-3/8	6/4	G3/8	11,5	29,5	12	20	50
C304 8-1/8	8/6	G1/8	8,0	25,0	14	14	50
C304 8-1/4	8/6	G1/4	11,0	29,0	14	17	50
C304 8-3/8	8/6	G3/8	11,5	29,5	14	20	50
C304 10-1/8	10/8	G1/8	8,0	26,5	16	14	50
C304 10-1/4	10/8	G1/4	11,0	30,5	16	17	50
C304 10-3/8	10/8	G3/8	11,5	31,0	16	20	25
C304 10-1/2	10/8	G1/2	14,00	34,5	16	24	20
C304 12-3/8	12/10	G3/8	11,5	32,5	18	20	20

UNION CONNECTOR / DROIT DOUBLE / DIRITTO INTERMEDIO

C305

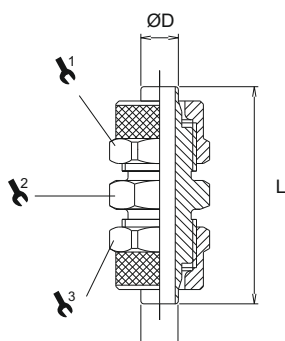

CODE	ØD	L				
C305 4	4/2,7	26,1	8	8	8	50
C305 5	5/3	28,5	8	8	8	50
C305 6	6/4	34,5	12	12	12	50
C305 8	8/6	35,0	14	14	12	50
C305 8-6	8/6x6/4	35,0	14	14	14	50
C305 10	10/8	38,0	16	16	14	25
C305 12	12/10	41,0	18	17	18	25
C305 15	15/12,5	45,5	22	22	22	10

BULKHEAD CONNECTOR / TRAVERSÉE DE CLOISON / DIRITTO PASSAPARETE

C306

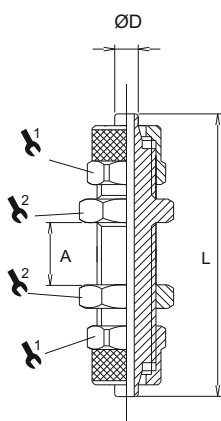

CODE	ØD	Amax	L			
C306 4	4/2,7	8,5	36,7	8	8	50
C306 5	5/3	8,5	40,0	8	9	50
C306 6	6/4	10,5	48,0	12	14	50
C306 8	8/6	10,5	48,0	14	16	50
C306 10	10/8	8,5	50,0	16	17	25
C306 12	12/10	8,5	53,0	18	19	20
C306 15	15/12,5	8,5	58,0	22	24	10

MALE ELBOW TAPER / ÉQUERRE MALE CONIQUE / L MASCHIO CONICO

C307

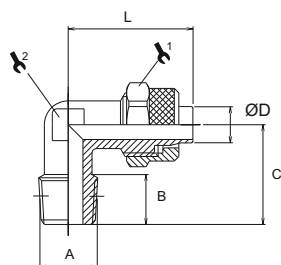
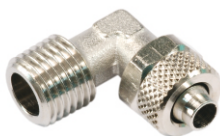

CODE	ØD	A	B	C	L	1	2	3
C307 4-1/8	4/2,7	R1/8	8,0	17,0	19,5	8	8	50
C307 5-1/8	5/3	R1/8	8,0	17,0	21,5	8	8	50
C307 6-1/8	6/4	R1/8	8,0	17,0	22,5	12	8	50
C307 6-1/4	6/4	R1/4	11,0	20,0	22,5	12	10	50
C307 6-3/8	6/4	R3/8	11,5	22,5	23,5	12	11	50
C307 8-1/8	8/6	R1/8	8,0	17,0	22,5	14	10	50
C307 8-1/4	8/6	R1/4	11,0	20,0	22,5	14	10	50
C307 8-3/8	8/6	R3/8	11,5	22,5	24,0	14	11	50
C307 10-1/8	10/8	R1/8	8,0	18,5	25,5	16	11	50
C307 10-1/4	10/8	R1/4	11,0	21,5	25,5	16	11	50
C307 10-3/8	10/8	R3/8	11,5	22,5	25,5	16	11	25
C307 10-1/2	10/8	R1/2	14,0	28,0	28,0	16	17	25
C307 12-1/4	12/10	R1/4	11,0	24,0	30,0	18	14	20
C307 12-3/8	12/10	R3/8	11,5	24,5	30,0	18	14	20
C307 12-1/2	12/10	R1/2	14,0	28,0	30,5	18	17	20
C307 15-1/2	15/12,5	R1/2	14,0	28,0	34,0	22	17	10

ROTARY MALE ELBOW PARALLEL / ÉQUERRE MALE CYLINDRIQUE / L GIREVOLE MASCHIO CILINDRICO

C308C

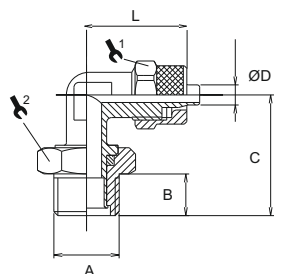

CODE	ØD	A	B	C	L	1	2	3
C308C 4-1/8	4/2,7	G1/8	6,0	22,5	21,5	12	14	50
C308C 6-1/8	6/4	G1/8	6,0	22,5	22,5	12	14	50
C308C 6-1/4	6/4	G1/4	8,0	25,0	23,5	12	17	50
C308C 8-1/8	8/6	G1/8	6,0	22,5	23,5	14	14	50
C308C 8-1/4	8/6	G1/4	8,0	25,0	23,5	14	17	50
C308C 10-1/4	10/8	G1/4	8,0	25,5	25,5	16	17	25

FEMALE ELBOW / ÉQUERRE FEMELLE / L FEMMINA

C310

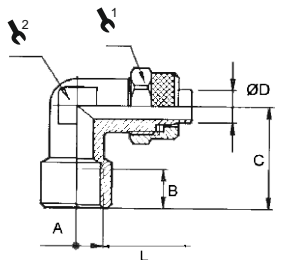

CODE	ØD	A	B	C	L	1	2	3
C310 5-1/8	5/3	G1/8	8,0	19,0	21,5	8	10	50
C310 6-1/8	6/4	G1/8	8,0	19,0	22,5	12	10	50
C310 6-1/4	6/4	G1/4	10,5	23,0	25,0	12	11	50
C310 8-1/8	8/6	G1/8	8,0	19,0	22,5	14	10	50
C310 8-1/4	8/6	G1/4	10,5	23,0	25,0	14	11	50
C310 10-1/4	10/8	G1/4	11,0	23,5	26,0	16	13	25
C310 12-3/8	12/10	G3/8	11,5	28,0	30,5	18	17	20

UNION ELBOW / ÉQUERRE DOUBLE / L INTERMEDIO

C311

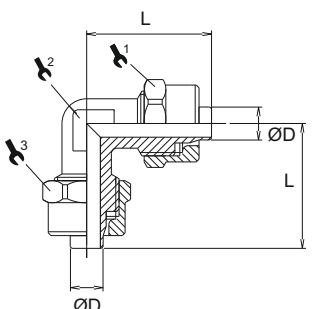

CODE	ØD	L	1	2	3	3
C311 4	4/2,7	20,3	8	8	8	50
C311 5	5/3	21,5	8	8	8	50
C311 6	6/4	21,5	12	8	12	50
C311 8	8/6	22,5	12	10	14	50
C311 8-6	8/6x6/4	22,5	14	10	14	50
C311 10	10/8	25,5	16	11	16	25
C311 12	12/10	30,0	18	14	18	20
C311 15	15/12,5	34,0	22	17	22	10

MALE TEE TAPER / T CONIQUE / T CENTRALE CONICO

C313

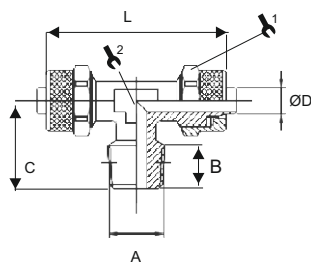

CODE	ØD	A	B	C	L	1	2	3
C313 4-1/8	4/2,7	R1/8	8,0	17,0	40,6	8	8	50
C313 5-M5	5/3	M5	4,0	15,0	43,0	8	8	50
C313 5-1/8	5/3	R1/8	8,0	17,0	43,0	8	8	50
C313 6-1/8	6/4	R1/8	8,0	17,0	45,0	11	8	50
C313 6-1/4	6/4	R1/4	11,0	20,5	45,5	11	10	50
C313 6-3/8	6/4	R3/8	11,5	22,5	47,0	12	11	50
C313 8-1/8	8/6	R1/8	8,0	17,5	45,5	14	10	50
C313 8-1/4	8/6	R1/4	11,0	20,5	45,5	14	10	50
C313 8-3/8	8/6	R3/8	11,5	21,5	48,0	14	11	50
C313 10-1/8	10/8	R1/8	8,0	18,5	51,0	16	11	50
C313 10-1/4	10/8	R1/4	11,0	21,5	51,0	16	11	50
C313 10-3/8	10/8	R3/8	11,5	22,5	51,0	16	11	25
C313 10-1/2	10/8	R1/2	14,0	28,0	57,0	16	17	25
C313 12-3/8	12/10	R3/8	11,5	22,5	60,0	18	14	20
C313 12-1/2	12/10	R1/2	14,0	28,0	61,0	18	17	20
C313 15-1/2	15/12,5	R1/2	14,0	28,0	68,0	22	17	10

MALE TEE PARALLEL / T CYLINDRIQUE / T CENTRALE CILINDRICO

C313C

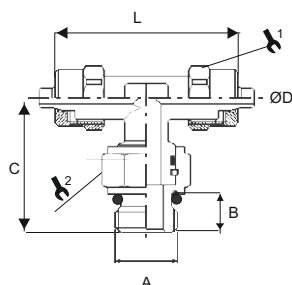

CODE	ØD	A	B	C	L	1	2	3
C313C 4-1/8	4/2,7	G1/8	6,0	25,7	45,0	8	13	25
C313C 6-1/8	6/4	G1/8	6,0	25,7	45,0	12	13	25
C313C 6-1/4	6/4	G1/4	8,0	29,0	45,5	12	16	20
C313C 8-1/8	8/6	G1/8	6,0	26,0	45,5	10	14	20
C313C 8-1/4	8/6	G1/4	8,0	28,0	45,5	14	16	20
C313C 10-1/4	10/8	G1/4	8,0	29,0	51,0	16	16	10

LATERAL MALE TEE TAPER / T LATERAL CONIQUE / T LATERALE CONICO

C314

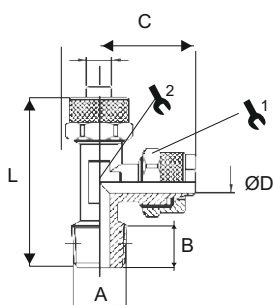

CODE	ØD	A	B	C	L	1	2	3
C314 4-1/8	4/2,7	R1/8	8,0	21,5	38,0	8	8	50
C314 5-M5	5/3	M5	4,0	21,5	36,5	8	8	50
C314 5-1/8	5/3	R1/8	8,0	21,5	38,5	8	8	50
C314 6-1/8	6/4	R1/8	8,0	22,5	39,5	12	8	50
C314 6-1/4	6/4	R1/4	11,0	22,5	42,5	12	10	50
C314 6-3/8	6/4	R3/8	11,5	24,0	46,5	12	11	50
C314 8-1/8	8/6	R1/8	8,0	22,5	40,5	14	10	50
C314 8-1/4	8/6	R1/4	11,0	22,5	43,5	14	10	50
C314 8-3/8	8/6	R3/8	11,5	23,5	46,5	14	11	50
C314 10-1/8	10/8	R1/8	8,0	25,5	44,0	16	11	50
C314 10-1/4	10/8	R1/4	11,0	25,5	46,5	16	11	50
C314 10-3/8	10/8	R3/8	11,5	25,5	48,0	16	11	25
C314 10-1/2	10/8	R1/2	14,0	29,0	57,0	16	17	25
C314 12-3/8	12/10	R3/8	11,5	30,0	54,5	18	14	20
C314 12-1/2	12/10	R1/2	14,0	30,5	58,5	18	17	20
C314 15-1/2	15/12,5	R1/2	14,0	34,0	62,0	22	17	10

C315



UNION TEE / T / T INTERMEDIO

CODE	ØD	C	L				
C315 4	4/2,7	20,3	20,3	8	8	8	50
C315 5	5/3	21,5	43,0	8	8	8	50
C315 6	6/4	22,5	45,0	12	8	12	50
C315 8-6	8/6x6/4	22,5	45,0	14	10	14	50
C315 8	8/6	22,5	45,0	12	10	14	50
C315 10	10/8	25,5	51,0	16	11	16	25
C315 12	12/10	30,0	60,0	18	14	18	20
C315 15	15/12,5	34,0	68,0	22	17	22	10

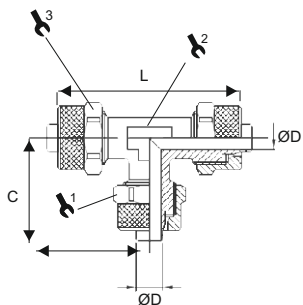

C322



NUT / ECROU / DADO

CODE	ØD	A	B		
C322 4	4/2,7	M6x0,5	8,1	8	50
C322 5	5/3	M7x0,75	8,5	8	50
C322 6-8	6/4	M8x0,75	9,0	9	50
C322 6	6/4	M10x1	10,5	12	50
C322 8	8/6	M12x1	10,5	14	50
C322 10	10/8	M14x1	11,5	16	25
C322 12	12/10	M16x1	13,0	18	20
C322 15	15/12,5	M20x1	15,5	22	10

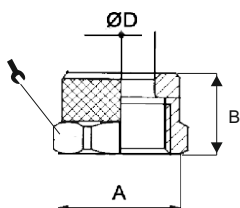

C312



CROSS UNION / CROIX / CROCE INTERMEDIO

CODE	ØD	L			
C312 5	5/3	43,0	8	8	20
C312 6	6/4	45,0	12	8	20
C312 8	8/6	45,0	14	10	20
C312 10	10/8	51,0	16	11	10

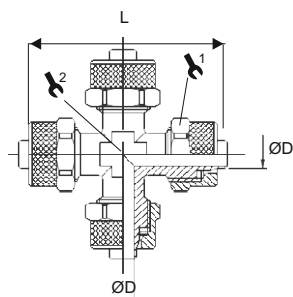

MALE CONNECTOR SWIVEL WITH SPRING PARALLEL / DROIT MÂLE CONIQUE AVEC RESSORT
DIRITTO MASCHIO GIREVOLE CONICO CON MOLLA

E533

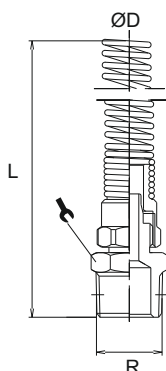

CODE	TUBO	R	L		
E533 6/4 1/4	6/4	1/4	113,0	14	10
E533 8/5 1/4	8/5	1/4	124,5	12	10
E533 8/6 1/4	8/6	1/4	128,0	14	10
E533 8/6 3/8	8/6	3/8	128,5	17	10
E533 10/8 1/4	10/8	1/4	125,0	14	10
E533 10/8 3/8	10/8	3/8	125,5	17	10
E533 12/10 3/8	12/10	3/8	140,0	22	10

MALE CONNECTOR SWIVEL WITH SPRING TAPER / DROIT MÂLE CONIQUE ROTATIF AVEC RESSORT
DIRITTO MASCHIO GIREVOLE CONICO CON MOLLA

E534

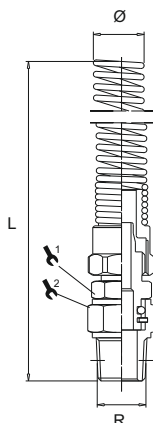

CODE	TUBO	R	L			
E534 6/4 1/4	6/4	1/4	118,9	15	13	10
E534 8/5 1/4	*	8/5	124,4	13	13	10
E534 8/6 1/4	8/6	1/4	124,4	16	16	10
E534 10/6,5 1/4	*	10/6,5	132,4	16	16	10
E534 10/8 1/4	10/8	1/4	132,4	13	13	10
E534 12/8 3/8	12/8	3/8	141,9	16	16	10
E534 12/10 3/8	12/10	3/8	141,9	16	16	10

* Special measures for PU tube
Mesures spécifiques pour tube de polyuréthane
Misure specifiche per tubo in poliuretano

ROTARY MALE CONNECTOR SWIVEL WITH SPRING PARALLEL / DROIT MÂLE CYLINDRIQUE AVEC RESSORT
DIRITTO MASCHIO GIREVOLE CON MOLLA /

E535

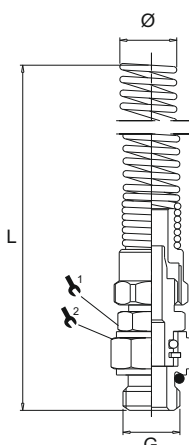

CODE	TUBO	G	L			
E535 6/4 1/8	6/4	1/8	116,9	13	13	10
E535 6/4 1/4	6/4	1/4	118,9	13	13	10
E535 8/5 1/8	*	8/5	122,4	16	16	10
E535 8/5 1/4	*	8/5	124,4	13	13	10
E535 8/6 1/8	8/6	1/8	122,4	16	16	10
E535 8/6 1/4	8/6	1/4	124,4	16	16	10
E535 10/6,5 1/4	*	10/6,5	132,4	16	16	10
E535 10/8 1/4	10/8	1/4	132,4	13	13	10
E535 12/8 3/8	12/8	3/8	141,9	16	16	10
E535 12/10 3/8	12/10	3/8	141,9	16	16	10

* Special measures for PU tube
Mesures spécifiques pour tube de polyuréthane
Misure specifiche per tubo in poliuretano

FIXED MALE CONNECTOR WITH SPRING PARALLEL / DROIT MÂLE CYLINDRIQUE AVEC RESSORT
DIRITTO MASCHIO FISSO CILINDRICO CON MOLLA

E536

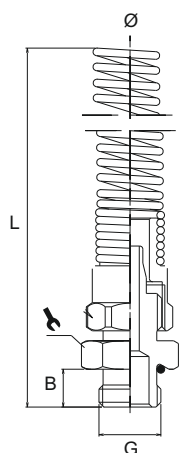

CODE	TUBO	G	B	L		
E536 6/4 1/8	6/4	1/8	6,0	111,0	13	10
E536 6/4 1/4	6/4	1/4	8,0	111,0	16	10
E536 6/4 3/8	6/4	3/8	9,0	112,0	19	10
E536 6/4 1/2	6/4	1/2	10,0	113,0	24	10
E536 8/6 1/8	8/6	1/8	6,0	110,0	14	10
E536 8/6 1/4	8/6	1/4	8,0	111,0	16	10
E536 8/6 3/8	8/6	3/8	9,0	112,0	19	10
E536 8/6 1/2	8/6	1/2	10,0	113,0	24	10
E536 10/8 1/8	10/8	1/8	6,0	116,0	14	10
E536 10/8 1/4	10/8	1/4	8,0	117,0	16	10
E536 10/8 3/8	10/8	3/8	9,0	118,5	19	10
E536 10/8 1/2	10/8	1/2	10,0	119,0	24	10
E536 12/10 3/8	12/10	3/8	9,0	129,0	19	10
E536 12/10 1/2	12/10	1/2	10,0	130,0	24	10

SINGLE BANJO BODY / BANJO ORIENTABLE / ANELLO ORIENTABILE SINGOLO

C316

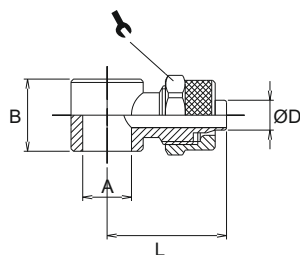

CODE	ØD	A	B	L		
C316 4/2,7-M5	4/2,7	M5	9,0	15,8	8	50
C316 4/2,7-M6	4/2,7	M6	9,0	15,8	8	50
C316 4/2,7-1/8	4/2,7	G1/8	14,5	21,3	8	50
C316 5/3-M5	5/3	M5	9,0	17,0	8	50
C316 5/3-1/8	5/3	G1/8	14,5	22,5	8	50
C316 6/4-M5	6/4	M5	9,0	18,0	9	50
C316 6/4-1/8	6/4	G1/8	14,5	24,0	12	50
C316 6/4-1/4	6/4	G1/4	14,5	26,0	12	50
C316 8/6-1/8	8/6	G1/8	14,5	24,0	14	50
C316 8/6-1/4	8/6	G1/4	14,5	26,0	14	50
C316 10/8-1/4	10/8	G1/4	14,5	27,5	16	25

DOUBLE BANJO BODY / BANJO ORIENTABLE DOUBLE / ANELLO ORIENTABILE DOPPIO

C317

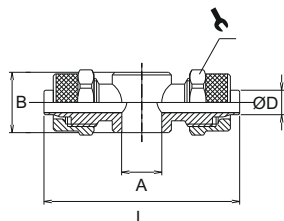

CODE	ØD	A	B	L		
C317 4/2,7-1/8	4/2,7	G1/8	14,5	42,6	8	50
C317 5/3-1/8	5/3	G1/8	14,5	45,0	8	50
C317 6/4-1/8	6/4	G1/8	14,5	48,0	12	50
C317 6/4-1/4	6/4	G1/4	14,5	52,0	12	50
C317 8/6-1/8	8/6	G1/8	14,5	48,0	14	50
C317 8/6-1/4	8/6	G1/4	14,5	52,0	14	50
C317 10/8-1/4	10/8	G1/4	14,5	55,0	16	25

SINGLE STEM / VIS SIMPLE / ASTA SINGOLA

C319

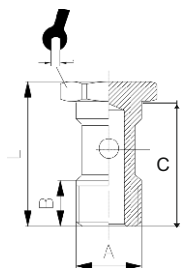

CODE	A	B	C	L		
C319 M5	M5	6,0	14,5	18,0	8	50
C319 M6	M6	6,0	14,5	18,5	8	50
C319 1/8	G1/8	8,0	23,0	27,0	14	50
C319 1/4	G1/4	11,0	25,0	29,5	17	50

DOUBLE STEM / VIS DOUBLE / ASTA DOPPIA

C321

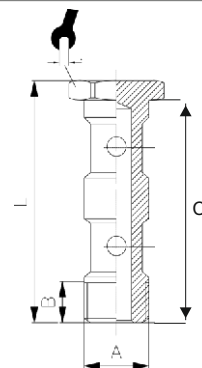

CODE	A	B	C	L		
C321 1/8	G1/8	8,0	39,0	43,0	14	50
C321 1/4	G1/4	11,0	41,0	45,5	17	50

NYLON WASHER / RONDELLE EN NYLON / DISTANZIALE NYLON

C327

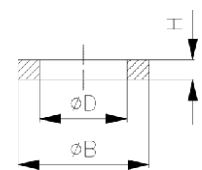

CODE	ØD	ØB	H	
C327 1/8	10,0	14,0	5,0	50
C327 1/4	13,2	17,5	5,0	50

FEMALE SINGLE BANJO / BANJO ORIENTABLE FEMELLE / ANELLO GIREVOLE FEMMINA

C318

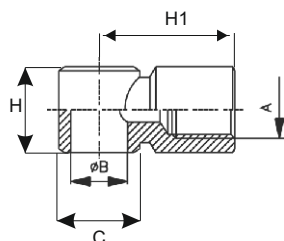

CODE	A	B	C	H	H1	
C318 1/8	G1/8	G1/8	14,0	14,5	20,0	25
C318 1/4	G1/4	G1/4	18,0	17,5	24,5	25
C318 3/8	G3/8	G3/8	21,0	21,0	29,0	20

NYLON NOTCHED WASHER / RONDELLE EN NYLON / RONDELLA NYLON DENTELLATA

C325

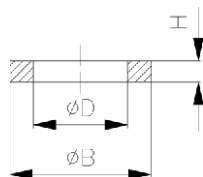

CODE	D	B	H	
C325 M5	5,2	8,0	1,3	100
C325 1/8	10,0	14,0	2,0	100
C325 1/4	13,5	18,0	2,0	100
C325 3/8	16,8	21,0	2,0	100
C325 1/2	21,1	26,0	2,0	100

NYLON WASHER / RONDELLE EN NYLON / RONDELLA NYLON

C324

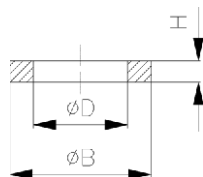

CODE	D	B	H	
C324 M5	5,3	7,7	1,0	100
C324 1/8	10,2	13,0	1,5	100
C324 1/4	13,4	17,9	2,0	100
C324 3/8	17,1	21,8	2,0	100
C324 1/2	21,3	26,5	2,0	100
C324 3/4	26,7	32,4	2,0	100

ALUMINIUM WASHER / RONDELLE EN ALUMINIUM / RONDELLA ALLUMINIO

C323

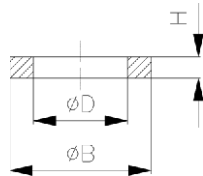

CODE	D	B	H	
C323 1/8	10,0	14,0	1,5	100
C323 1/4	10,3	17,3	1,5	100
C323 3/8	16,9	21,0	1,5	100
C323 1/2	21,1	26,0	1,5	100